

DESCRIPTION

Designed for paging calls and general announcements, the PM-660D desk-top microphone comes with a large talk switch and a lock lever for easy and convenient operation. Its robust anti-vibration construction and balanced output render the microphone resistive to noise.

In addition, the PM-660U microphone is equipped with a remote control switch (interlocked with the talk switch) for amplifier power on/off operation or chime activation.

SPECIFICATIONS

Type	Moving coil microphone
Polar Pattern	Unidirectional
Rated Impedance	600 Ω, Balanced
Rated Sensitivity	-58 dB (1 kHz, 0 dB=1 V/Pa)
Frequency Response	100 Hz - 10 kHz
Output	4-conductor (2-shielded) cable (2.5 m (8.2 ft)) with 5-pin DIN plug
Talk Switch	1-push-to-talk switch, 1-locking lever, Short-off type
Remote Control	500 mA or less at 30 V DC
Operating Temperature	-10 °C to +50 °C (14 °F to 122 °F)
Operating Humidity	95 %RH or less (no condensation)
Finish	Microphone head: Zinc plated steel wire, gray baked paint Main unit: ABS resin, gray
Dimensions	100 (W) × 215 (H) × 150 (D) mm (3.94" × 8.46" × 5.91")
Weight	400 g (0.88 lb) (cord excluded)

※ Do not keep the lock lever placed in the locked state (ON position) for a long period of time. Doing so may cause poor conductivity in the lever switch due to deterioration with age, resulting in unit malfunction.

APPEARANCE

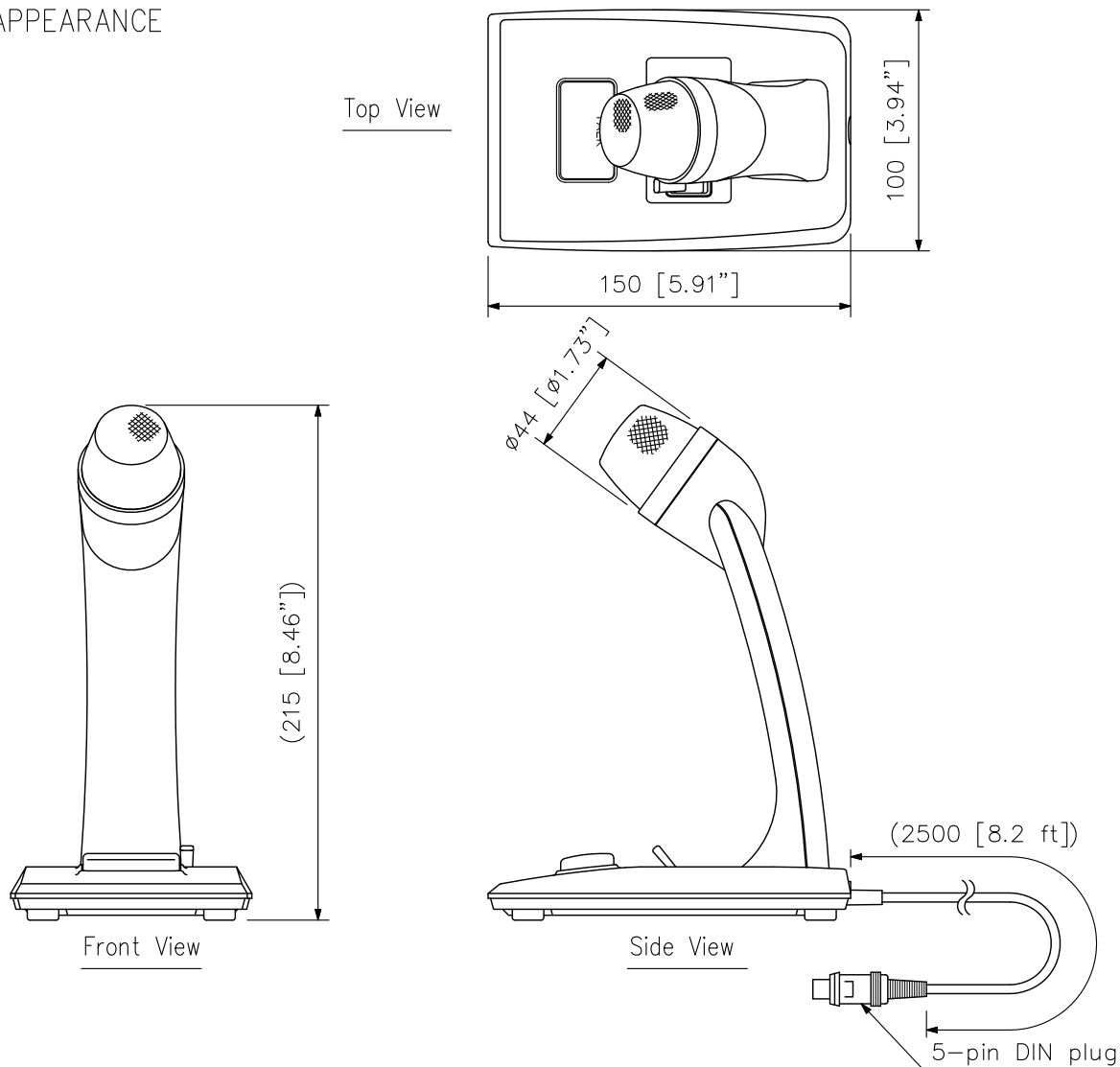

UNIT:mm SCALE:1/3

Note: Numerical values in parentheses are for reference only.